

A0201 DISPLAY A

OVERALL HEIGHT = 99 1/2"
 FULL HEIGHT =
 UPPER HEIGHT = 37 3/4"
 UPPER DEPTH = 13 1/2"

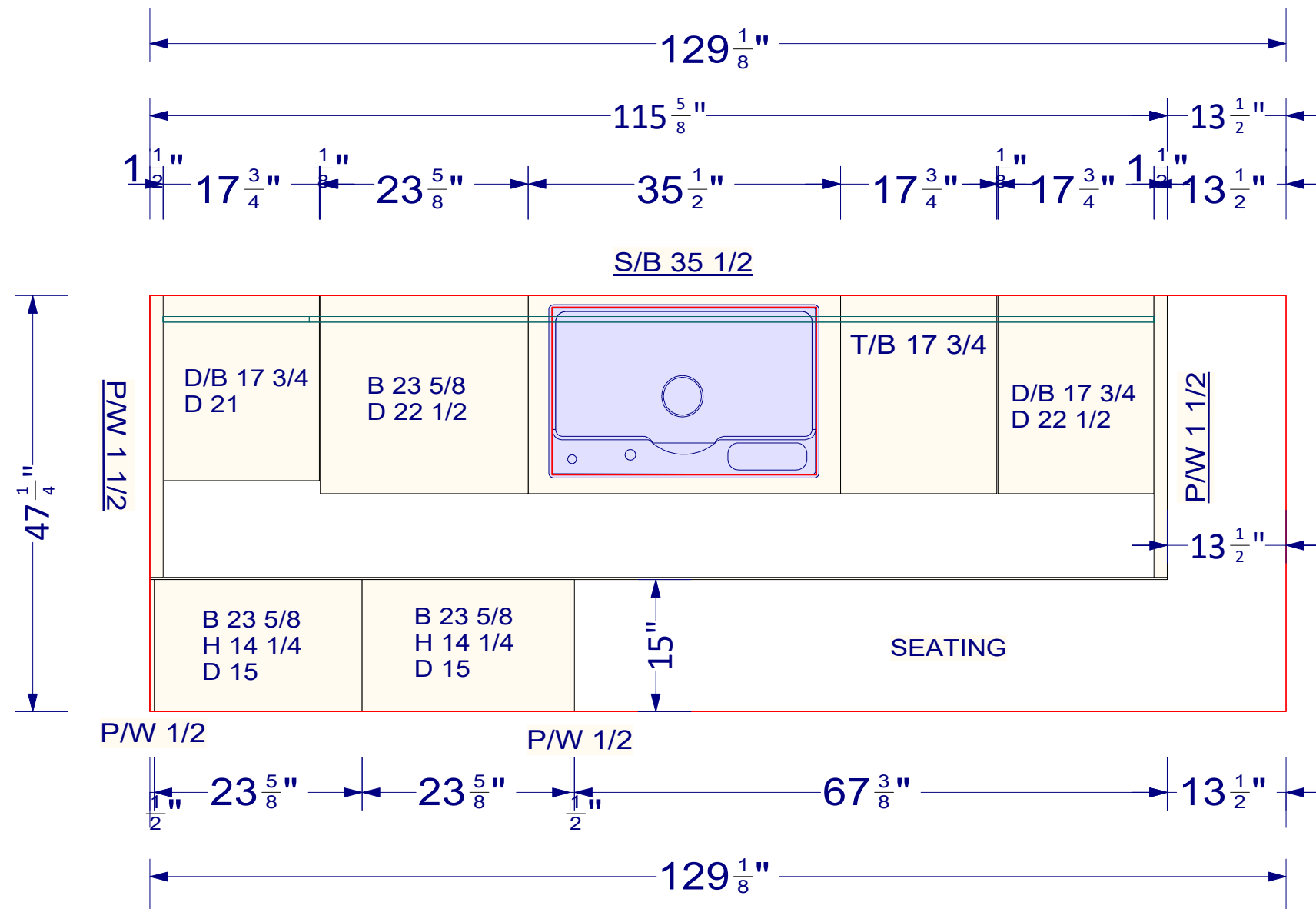

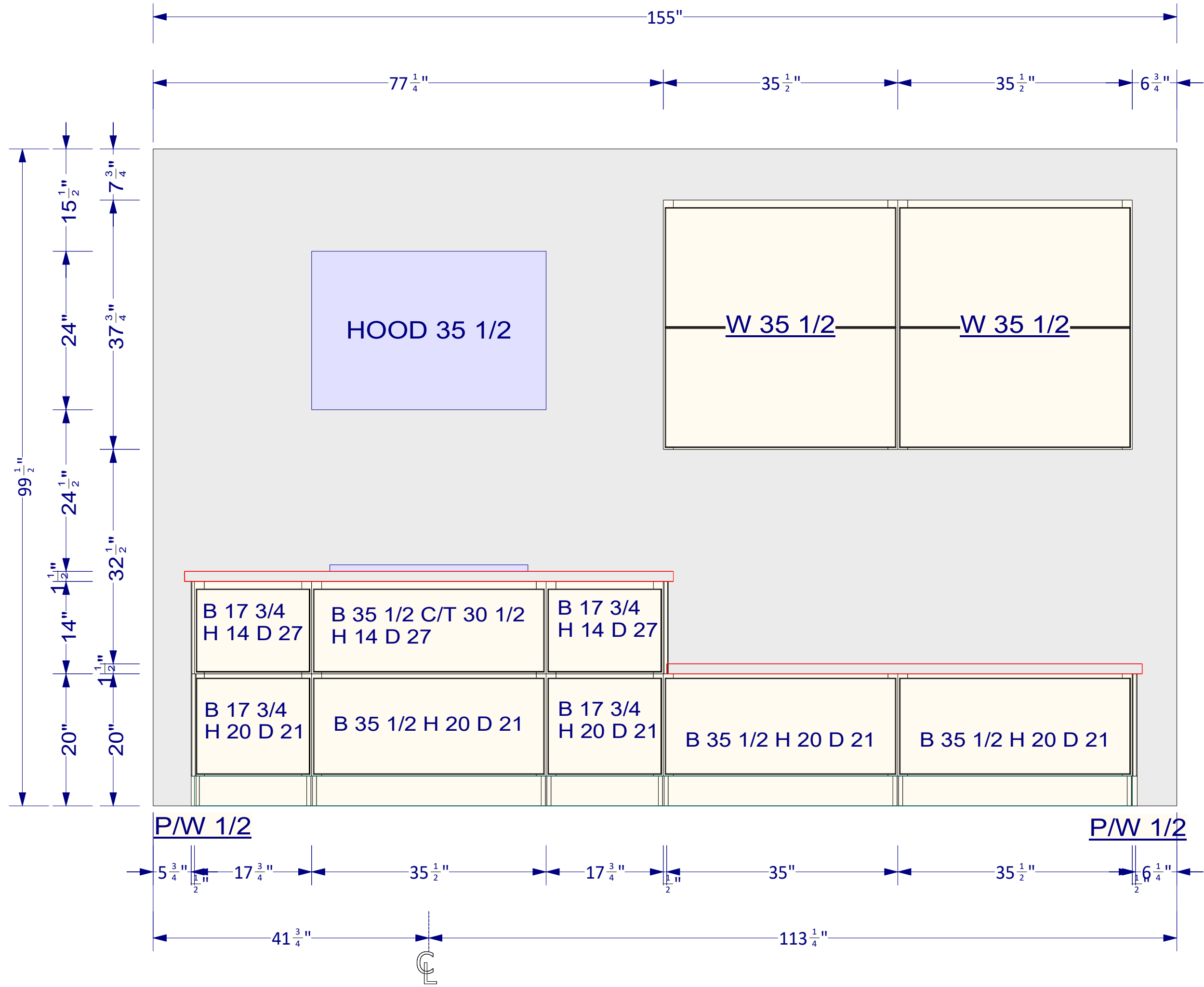

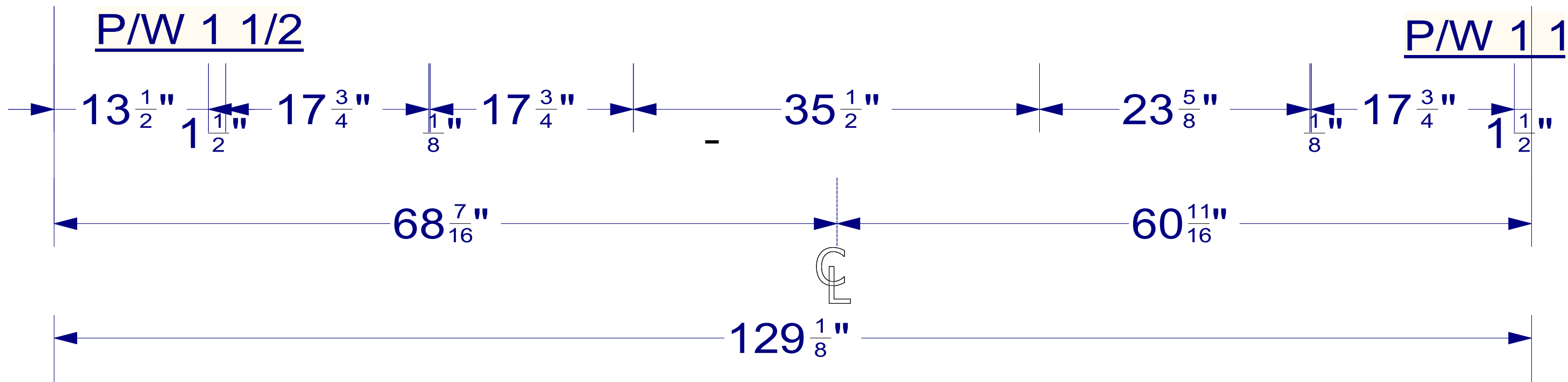
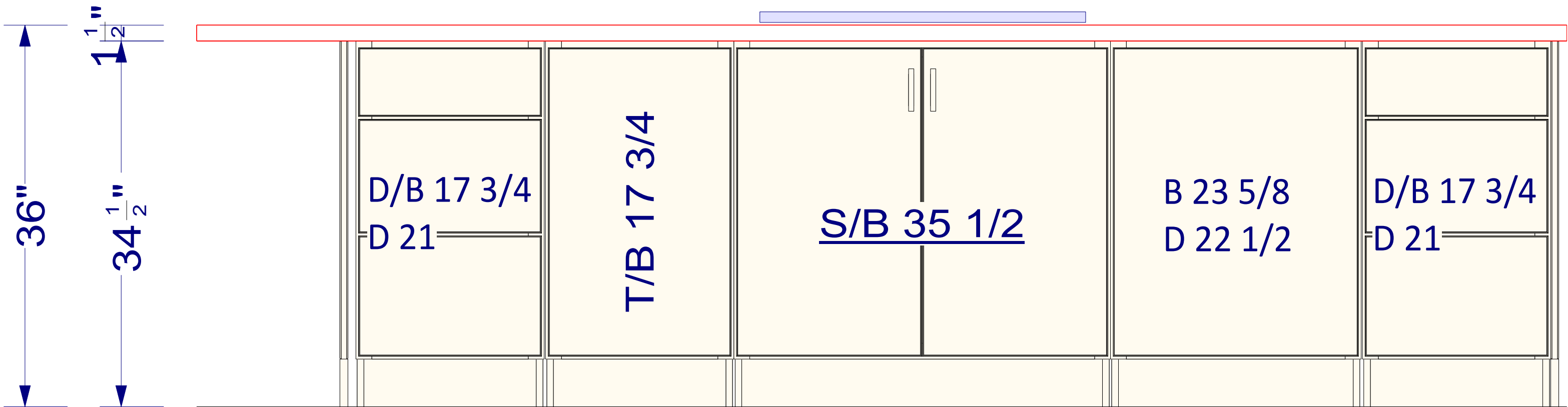

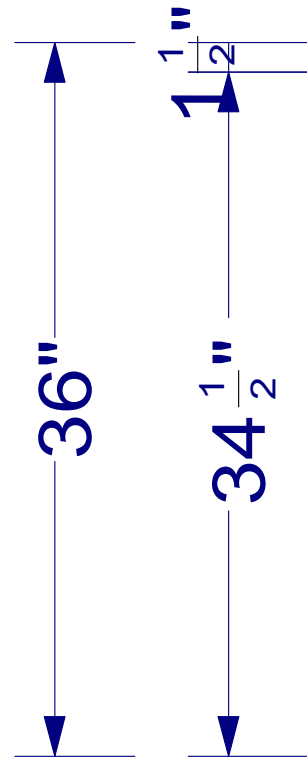

P/W 1/2

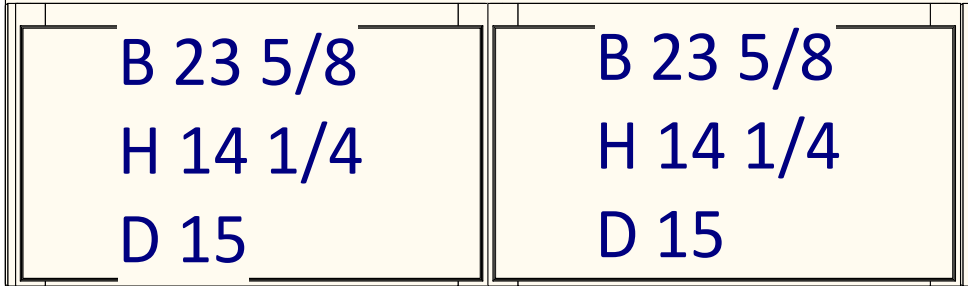

P/W 1/2

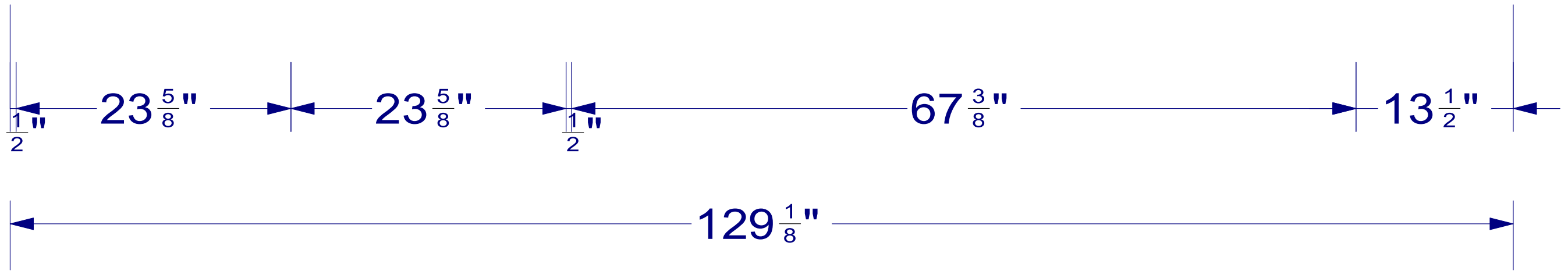

$23 \frac{5}{8}$ "

$23 \frac{5}{8}$ "

$67 \frac{3}{8}$ "

$13 \frac{1}{2}$ "

$129 \frac{1}{8}$ "